



**P H O E N I X**  
Household 2025



The  
extraordinary  
has always  
broken the  
established





# OUR STORY

The journey of Phoenix begins in 1976, when an advertisement in the newspaper showcased the sale of a plastic factory. The dying embers of the machinery piqued an interest in Mr. Omar. He took his son to see the injection molding factory, something neither had ever seen before. Mr. Omar's vision always led him toward the new and exciting. After playfully bidding, they acquired not just a factory, but a lifelong business and passion.

As the machines got refurbished, and other challenges were tackled, a vision for a new company emerged. The once dilapidated factory became a household brand, known and adored by every Sri Lankan.

Like a phoenix rising from its ashes, the company became a hotspot for entrepreneurial vision. It made many valuable partnerships along the way, which have been key contributors to the company's rise today. With over 40 years of industrial experience, Phoenix has expanded exponentially.

For the Omar family, Phoenix has been a guiding light; a springboard for many future successes, ventures and adventures. Phoenix is about resurgence and resilience.





# DESIGNED FOR LIFE

## PHOENIX LIVES FOR YOU

Our purpose is to make every moment of your life practical, smart, seamless and beautiful. We imagine, create and manufacture products envisioning what can give you the most trust, comfort and support everything you would look for in a life partner! Look around, and you'll see we're right there with you. We are a part of your life - we design for life.



**CONTENTS**





# NEW















**LID : Polypropylene and Silicone Seal**

Crafted from Polypropylene material, the lid features a silicone seal for an airtight, leak-proof closure.



**CONTAINER : Tritan**

Tritan is a high-performance, BPA-free material known for its exceptional durability, strength, and resistance to impacts, stains, and odors, making it a safe and reliable choice for food storage and everyday use.



Stain-free



Odor-free



Freezer-safe



Microwave-safe



Dishwasher-safe

### 300ml YUMMY FOOD CONTAINER

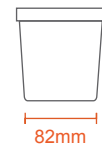
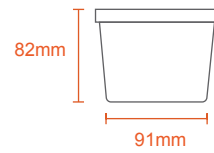

73g



Lid - Polypropylene  
& Silicone Seal  
Container - Tritan

### 700ml YUMMY FOOD CONTAINER

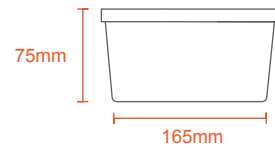

121g



Lid - Polypropylene  
& Silicone Seal  
Container - Tritan

### 1200ml YUMMY FOOD CONTAINER

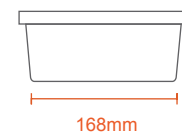
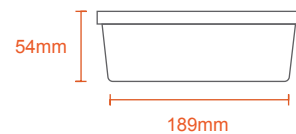

198g



Lid - Polypropylene  
& Silicone Seal  
Container - Tritan

### 1800ml YUMMY FOOD CONTAINER

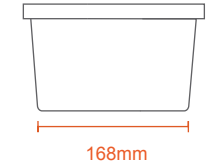
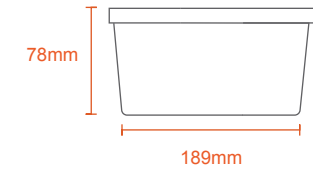

230g



Lid - Polypropylene  
& Silicone Seal  
Container - Tritan

### 2800ml YUMMY FOOD CONTAINER

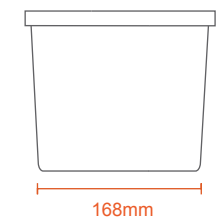
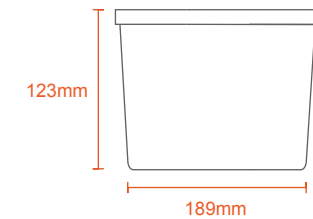

283g



Lid - Polypropylene  
& Silicone Seal  
Container - Tritan



# WASTE MANAGEMENT

In the age of climate change, disposing off waste is a critical responsibility. We create waste management solutions with empathy and respect for earth above all else. The relationship between human and nature is built on trust. Our waste segregation solutions bring you one step closer toward building this relationship. Our bins blend into every home and offer a sincere trust with nature.





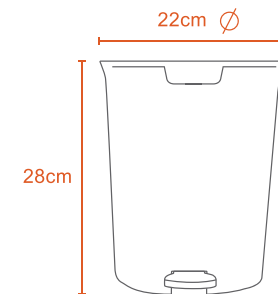

5L



0.5Kg



Polypropylene



# PEDAL BIN

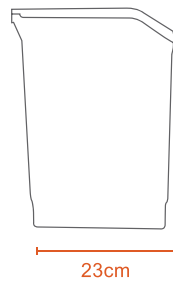
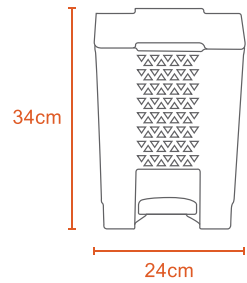

10L

0.8Kg

Polypropylene

# SQUARE BIN

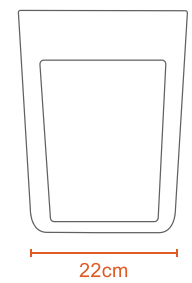
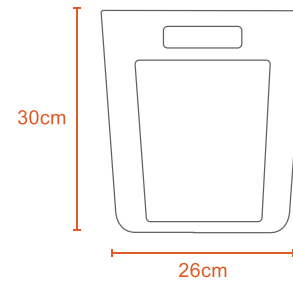

15L

0.3Kg

Polypropylene

# OWAL



PEDAL BIN



Beige/  
Brown

Blue/  
Orange/  
Yellow



Silver/  
Dark  
Green

Silver/  
Yellow



Silver/  
Red

Silver/  
Dark  
Blue

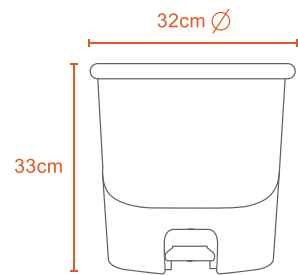

14L



1Kg



Polypropylene

# DELUX

PEDAL BIN



Silver/  
Blue



Silver/  
Red



Silver/  
Orange



Silver/  
Yellow



Silver/  
Green

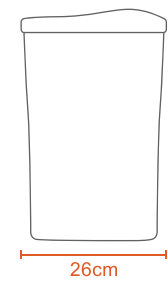
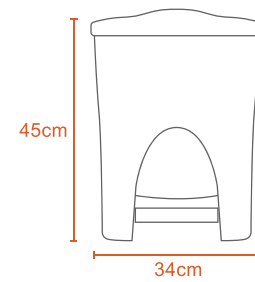

18L



1.5Kg



Polypropylene



# HEAVY DUTY

PEDAL BIN

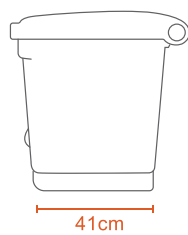
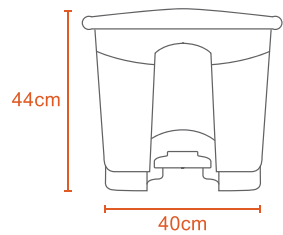

30L

2Kg

Polypropylene

# DOME

PUSH BIN

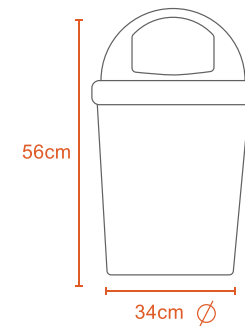

30L

1Kg

Polypropylene

# GARBAGE PEDAL BIN

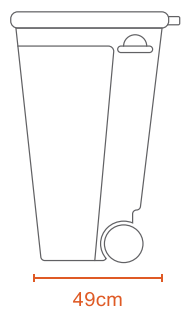
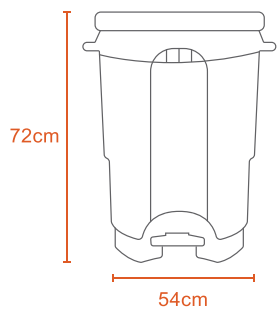

# TRASH BIN

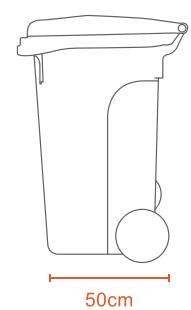
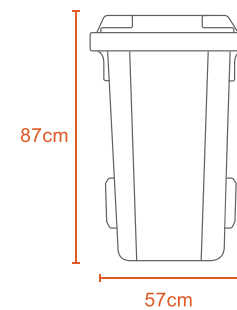



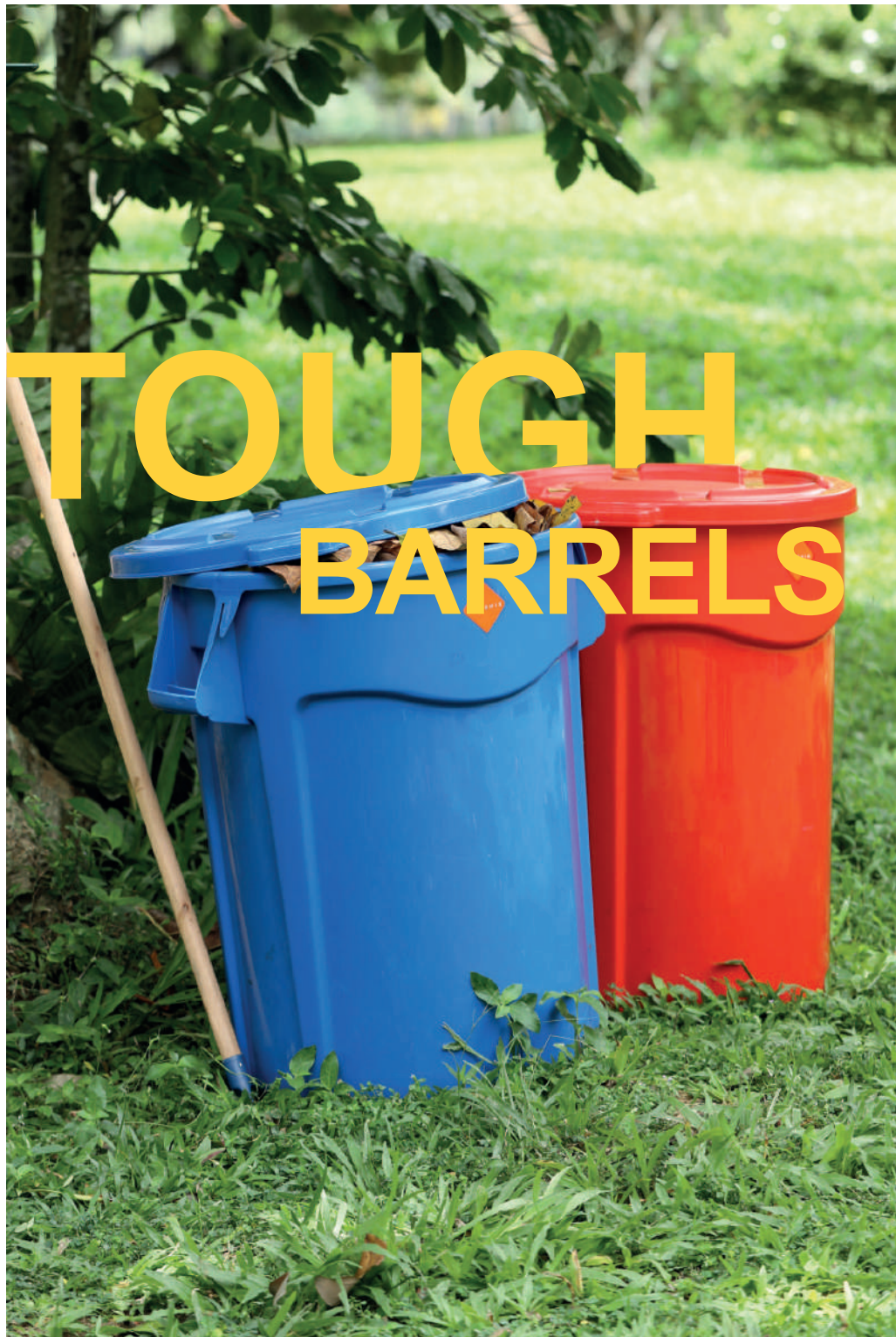

### 38L TOUGH BARREL

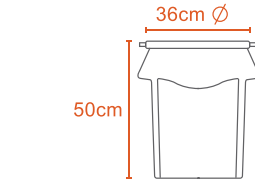

### 75L TOUGH BARREL

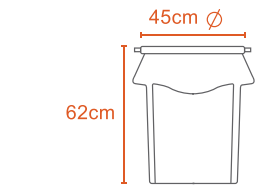

### 120L TOUGH BARREL

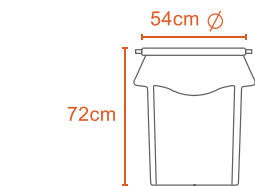



## 20L BARREL

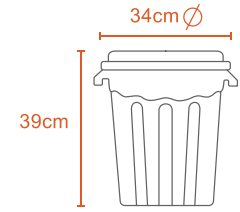

20L



0.6Kg



Polypropylene

## 25L BARREL

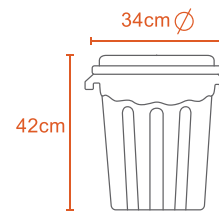

25L



0.8Kg



Polypropylene



## 45L BARREL



45L



1Kg



Polypropylene

## 65L BARREL



65L



Kg

2Kg



Polypropylene

## 50L BARREL



50L



Kg

1.5Kg



Polypropylene

## 100L BARREL



100L



Kg

3Kg



Polypropylene

# COMPOST BIN

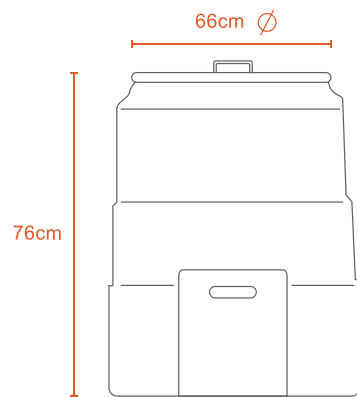

160L

5Kg

Polypropylene

# SWING LID BIN



100L

3.5Kg

Polypropylene



# CLEAN

When your home is clean, you're at peace. Our ergonomically designed products make cleaning not just easier but also the perfect antidote to stress. Cleaning doesn't just make the home brighter, but cleanses you from within. With our wide variety of seamlessly designed tools, cleaning can be a transformative activity not just for the house, but for the soul.





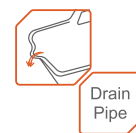
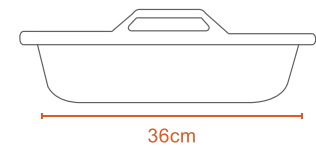
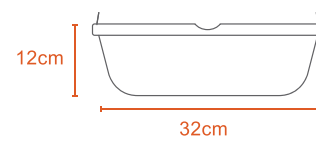



# SINGLE BIN

MOP BASKET

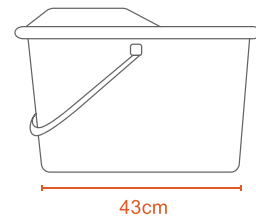
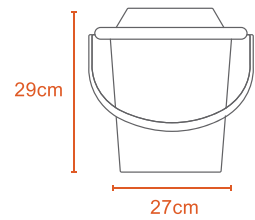

# TWIN BIN

MOP BASKET

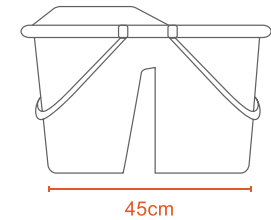
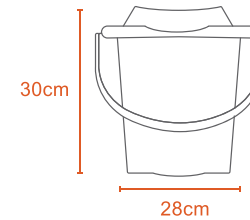

# PAILS



## 5L PAIL

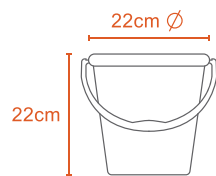

5L



0.2Kg



Polypropylene

## 10L PAIL

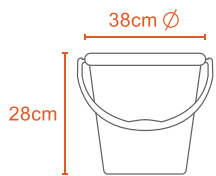

10L



0.4Kg



Polypropylene

## 15L PAIL



15L



0.6Kg



Polypropylene

## 18L PAIL



18L



0.7Kg



Polypropylene

## 25L PAIL



25L



1Kg



Polypropylene



# LAUNDRY

Our clothes embark on a journey with every laundry cycle - going from worn, to washed, to being put away for the next use. The distance between each task can become hassle-free through our ventilated laundry baskets. Every small detail adds to the ease of doing chores. We believe that no task should be painful or dreaded. A burst of color can ignite energy into the smallest errand.





## BUTTON LAUNDRY BASKET

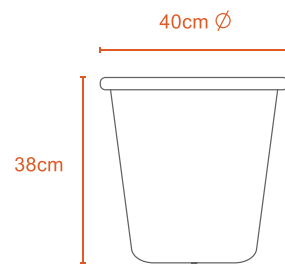

32L



1Kg



Polypropylene

## BUTTON L LAUNDRY BASKET

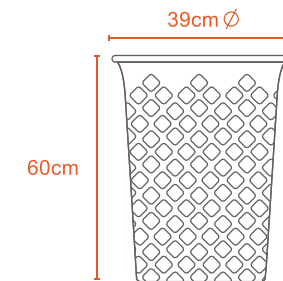

46L



1Kg



Polypropylene



# RATTAN



LAUNDRY BASKET

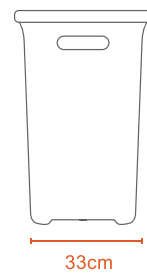
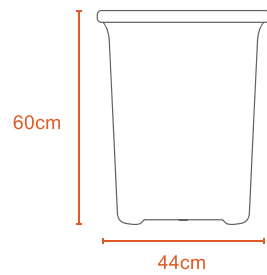

60L



2Kg



Polypropylene

# ELITE

LAUNDRY BASKET

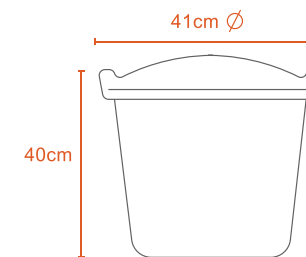
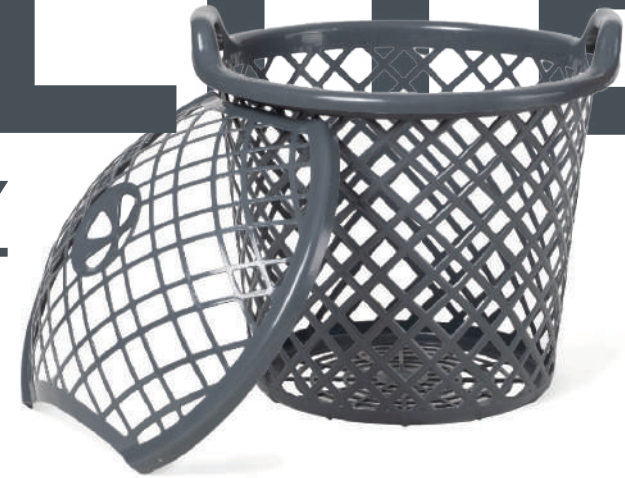

25L



0.4Kg



Polypropylene

# CANOE BASINS



## 15L canoe BASIN

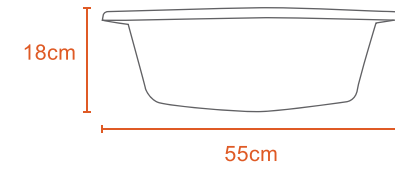

## 25L canoe BASIN

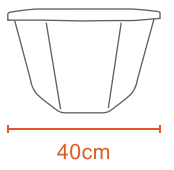
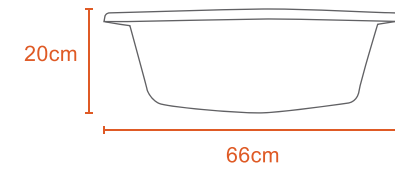

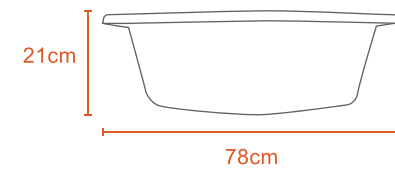

## 35L canoe BASIN



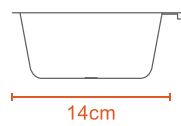
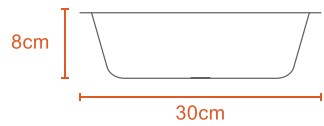

# SOAP TRAY



  
Kg  
0.08Kg

  
Polypropylene

# DRAIN PLUG



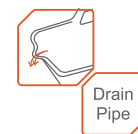
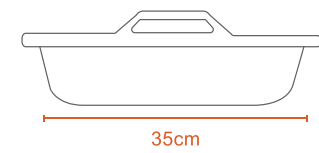
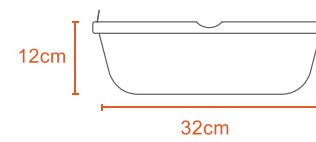





### 10L BASIN

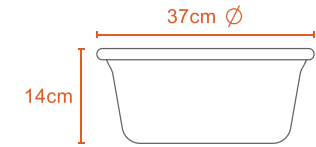

10L



0.2Kg



Polypropylene

### 18L BASIN

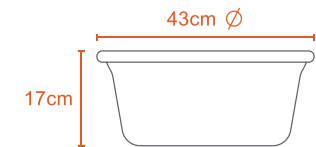

18L



0.4Kg



Polypropylene

### 20L BASIN

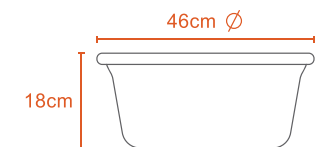

20L



0.5Kg



Polypropylene

### 28L BASIN

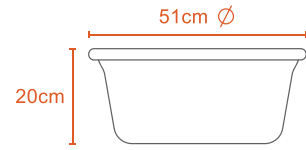

### 30L BASIN

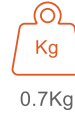
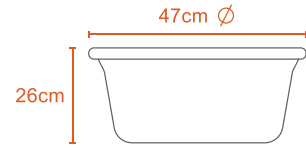

### 30L BASIN - CLASSIC

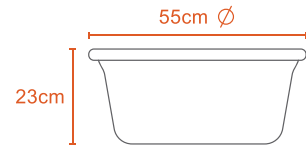

### 45L BASIN

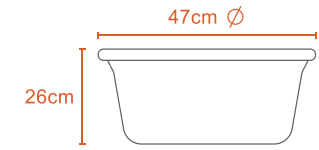

### 60L BASIN

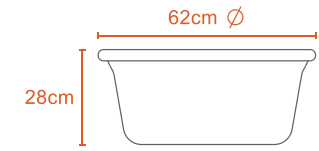

### 67L BASIN

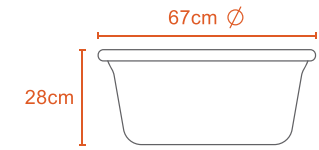



# KITCHEN

The vibrancy of a kitchen comes from plates full of food and a hall full of chatter. The warmth of a dinner party, with a simmering pot on the stove, and laughter all around shouldn't end with chaos. A well-organized kitchen employs practical and comfortable solutions. That's why we provide remedies for packing, storing, arranging, and even preserving food. No one likes dampening the mood with a messy clean-up process. Let the aroma of food linger.



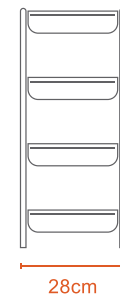
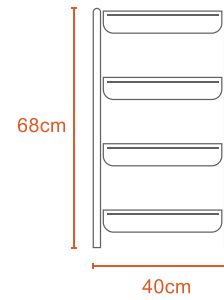
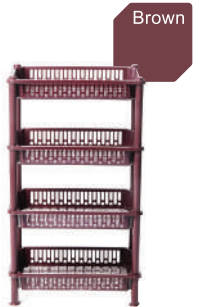
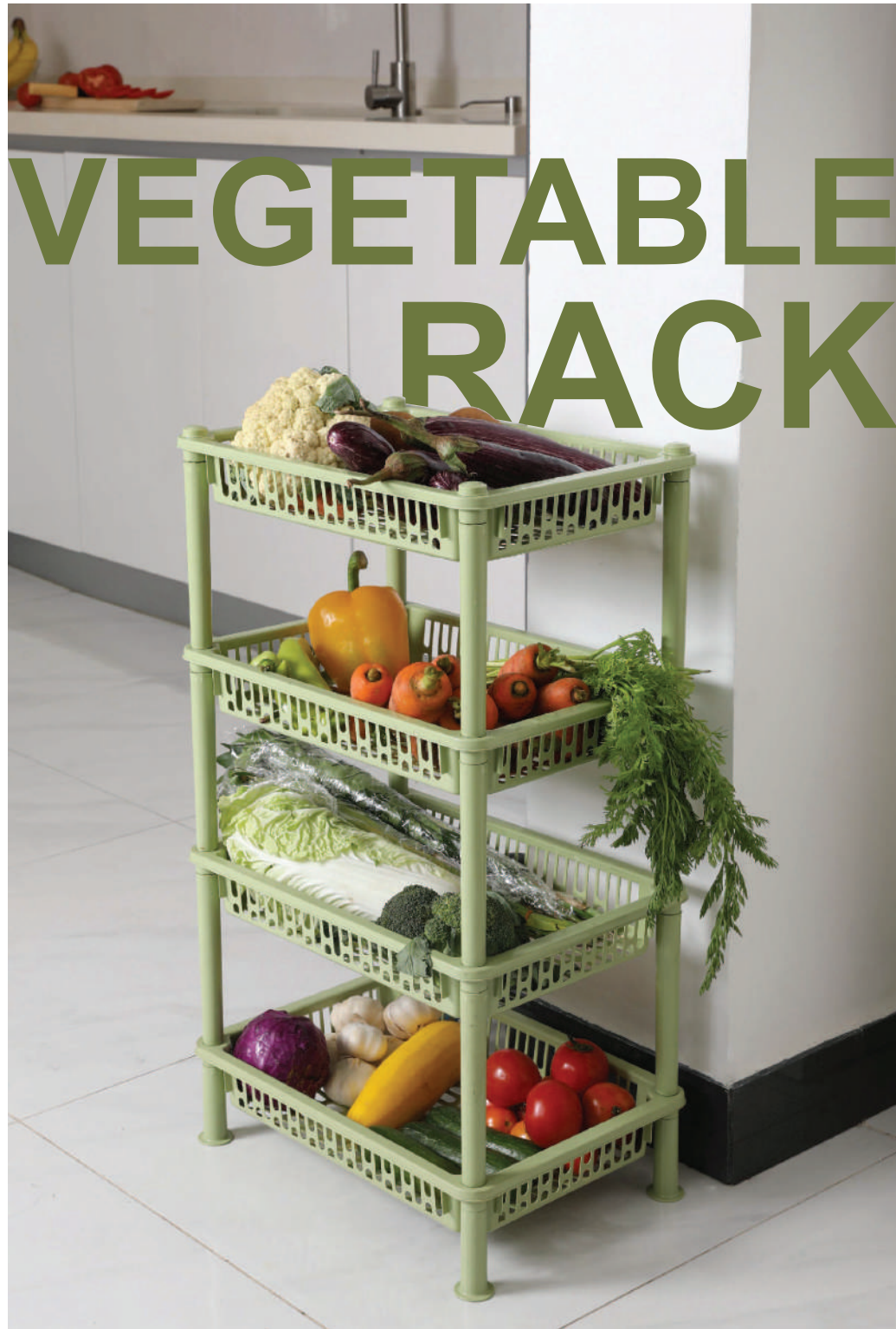

Kg  
0.8Kg

Polypropylene



# PRIME

## PLATE RACK



Fog



White



Marble

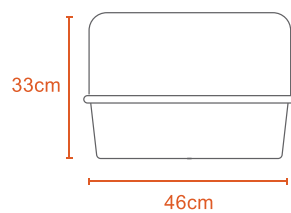

33cm

46cm

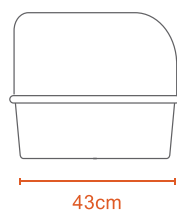

43cm



Kg

2Kg



Polypropylene

# PLATE RACK

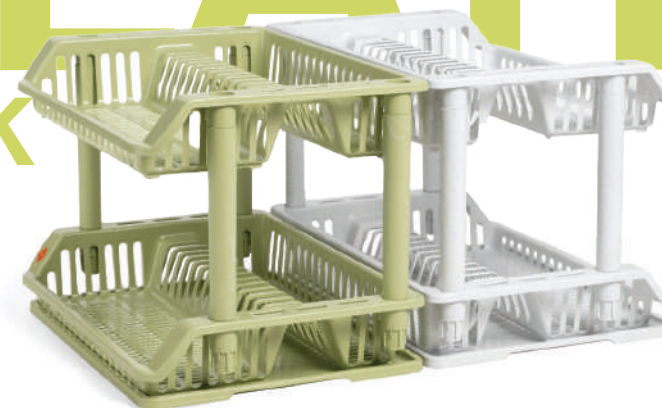

Light Green



Marble

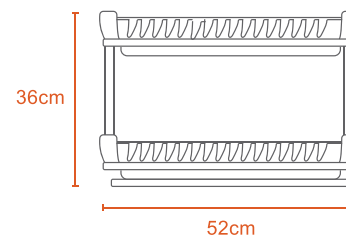

36cm

52cm

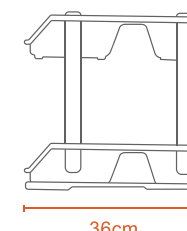

36cm



Kg

1Kg



Polypropylene



## 1KG LOOP FOOD CONTAINER

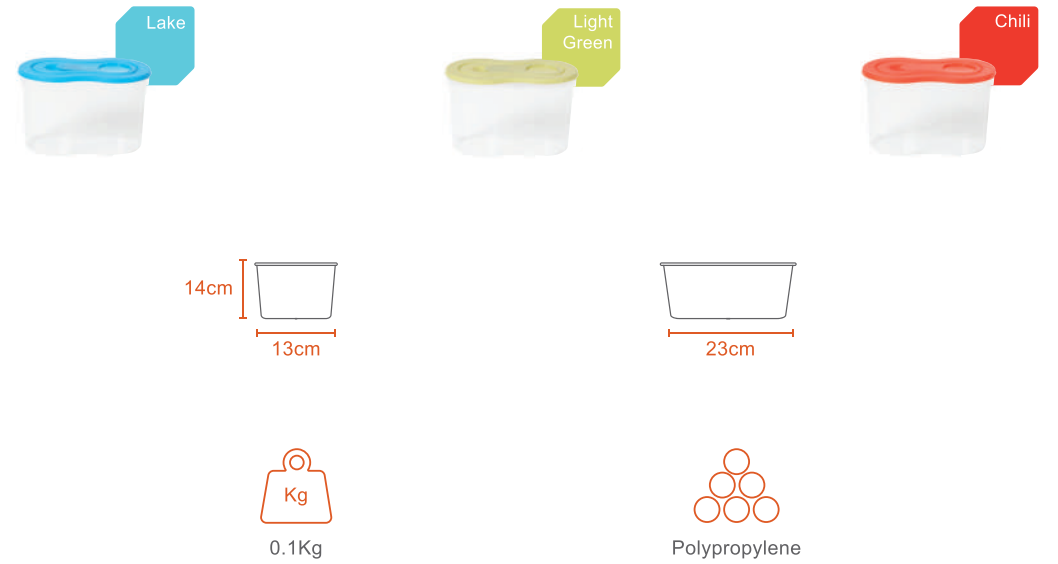

## 2KG LOOP FOOD CONTAINER







### 350ml CONTAINER

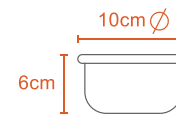

0.03Kg



Polypropylene

### 630ml CONTAINER

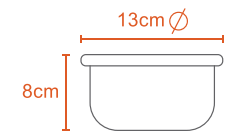

0.06Kg



Polypropylene

### 1870ml CONTAINER

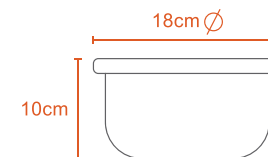

0.1Kg



Polypropylene

### 2800ml CONTAINER

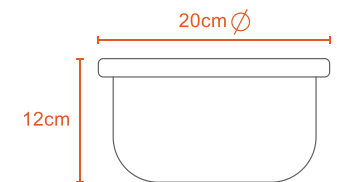

0.1Kg



Polypropylene

## 750ml CONTAINER PRO

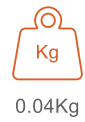
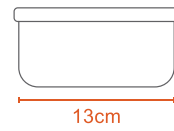
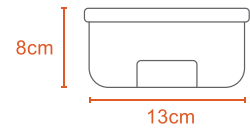

## 1500ml CONTAINER PRO

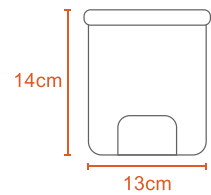
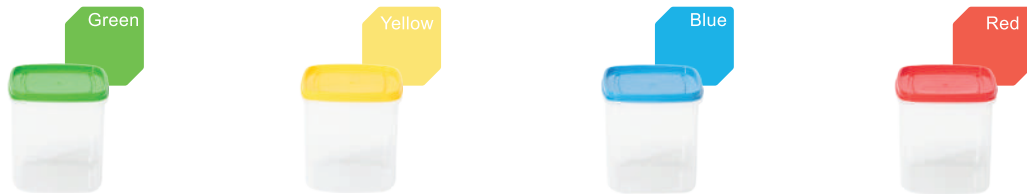

## 1650ml CONTAINER PRO

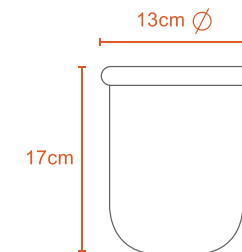
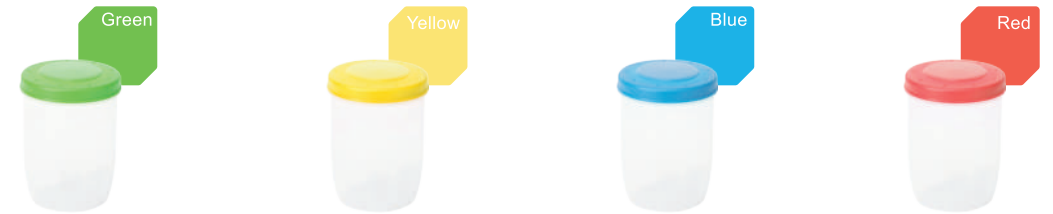



# ROUND

FOOD COVER



Light Green



Fog



Marble

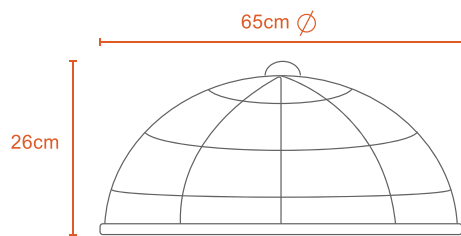

0.7Kg



Polypropylene

# SQUARE

FOOD COVER



Light Green



Fog



Marble

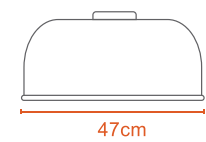
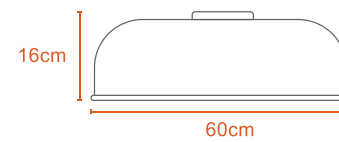

0.4Kg



Polypropylene

# GARDEN

In the midst of sun kissed skies and birdsong, why not equip yourself with a handy tool that can facilitate your labor? We know that gardens are like a canvas; a good solution only makes your patience run longer. As you tend to your garden, letting yourself be guided through the rhythm of nature, let us thrive by nurturing your passion.







# GRO

FLOWER POTS



### 4L GRO (S) FLOWER POT + TRAY

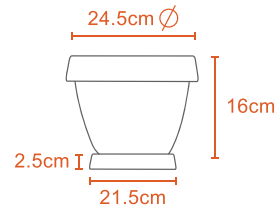

### 12L GRO (L) FLOWER POT + TRAY

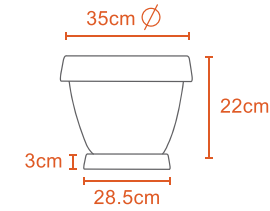

### 8L GRO (M) FLOWER POT + TRAY

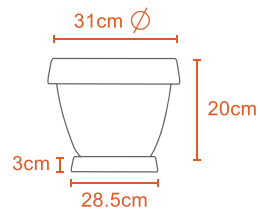

### 27L GRO (XL) FLOWER POT + TRAY

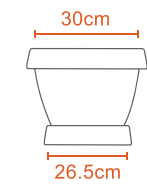
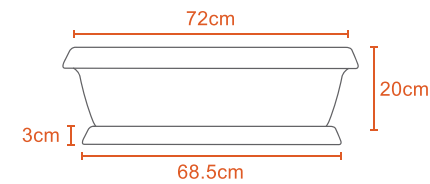



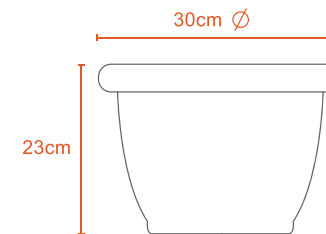

0.3Kg



Polyethylene / Polypropylene  
(Both options available)







## MONSOON WATERING CAN

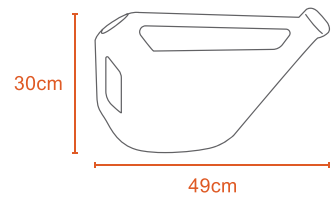

10L



0.5Kg



Polyethylene Body & Polypropylene Spout  
(Color may vary)

## LITTLE MONSOON WATERING CAN

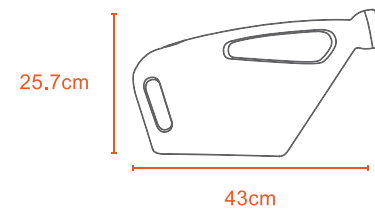

5L



0.4Kg



Polyethylene Body & Polypropylene Spout  
(Color may vary)

# KIDS

Children have the ability to find wonder in everything. We create products that not only lengthen their ability to imagine, but also make learning a joyful experience. You will never have to separate learning from play-time again. If children can see creativity in everything, why not raise children in a creative way?





# OLI

## KIDS CHAIR



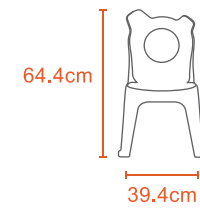



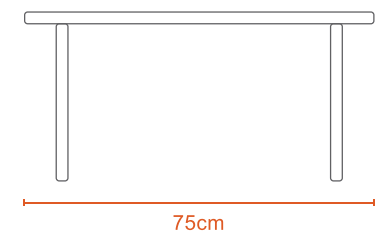
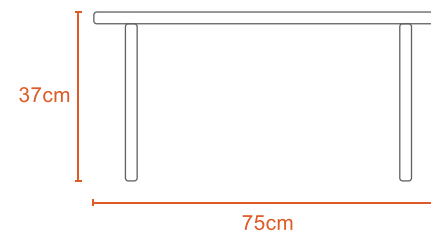

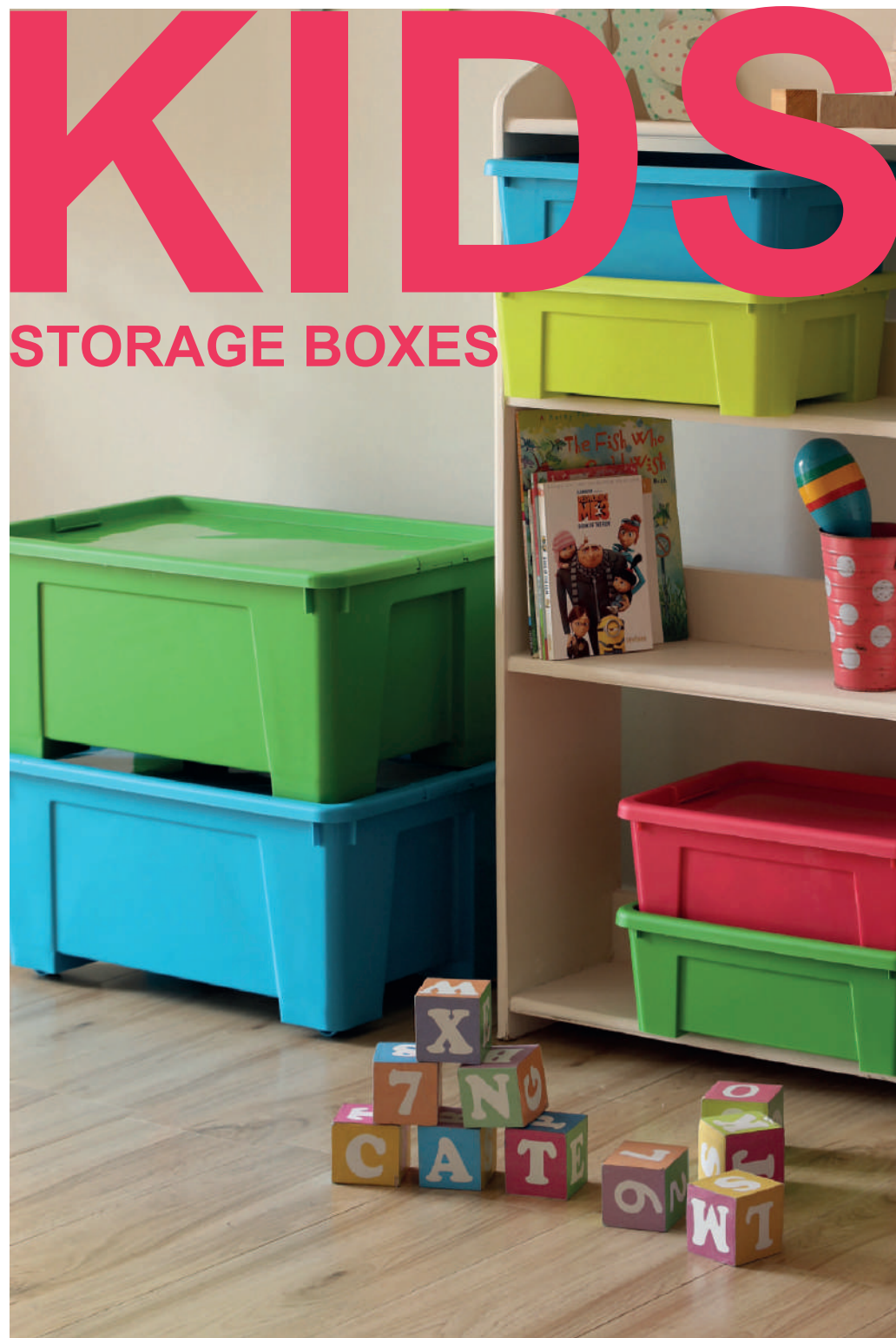

## 10L STORAGE BOX

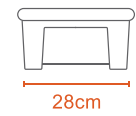
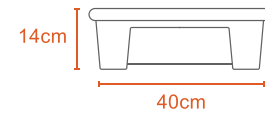

10L



0.6Kg



Polypropylene

## 45L STORAGE BOX

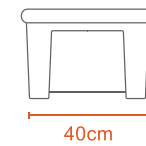
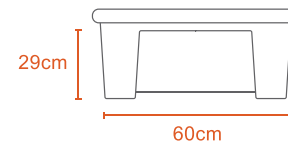

45L



2Kg



Polypropylene



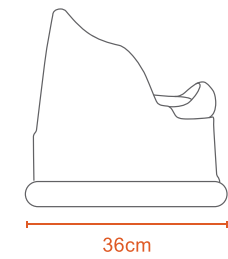
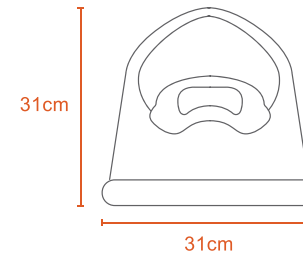
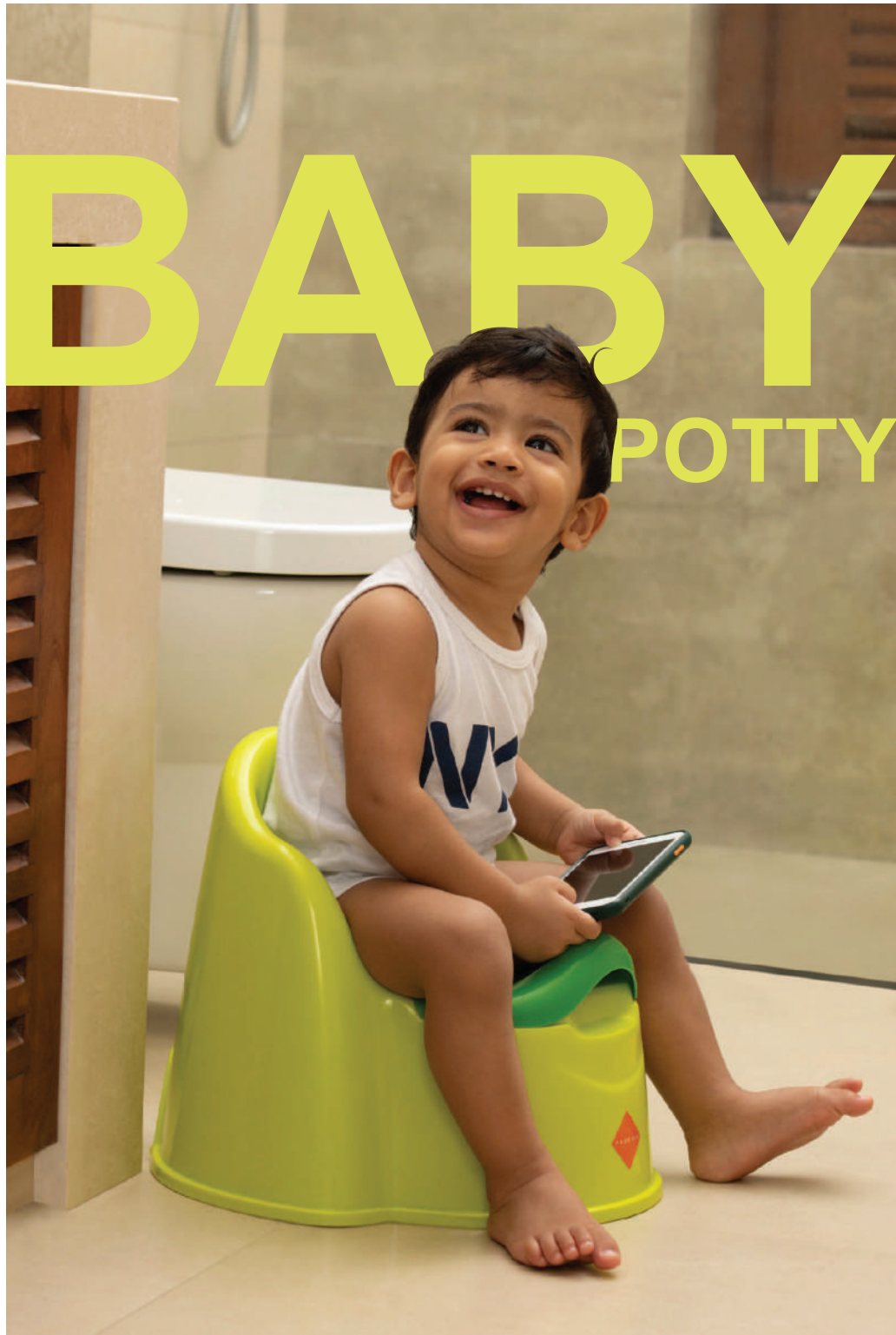





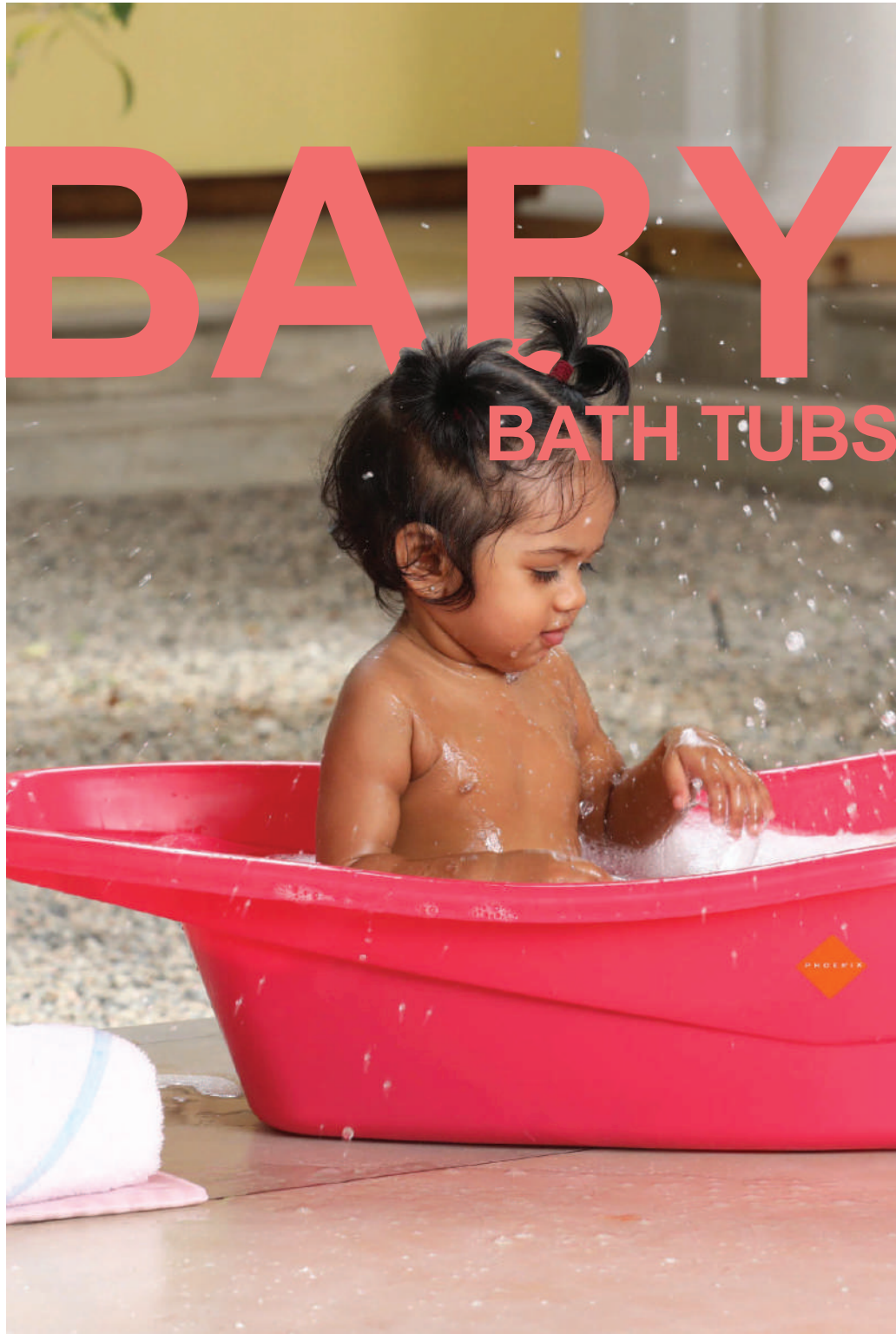

0.7Kg







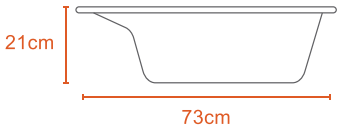
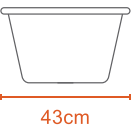

Polypropylene



**PRINCESS** BABY BATH TUB

 	 
	
 0.7Kg	 Polypropylene

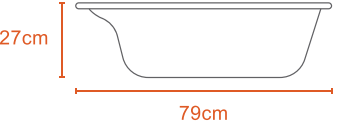
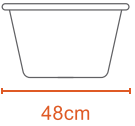
**NEW LARGE** BABY BATH TUB

 	 
	
 1Kg	 Polypropylene





# BABY ROCKING CHAIR

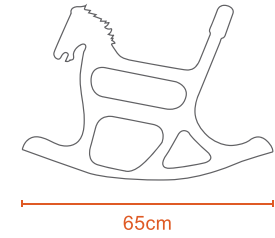
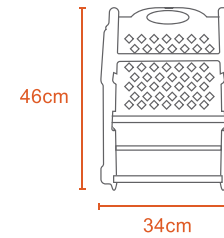

1.5Kg



Polypropylene



# KIDDIES DESK

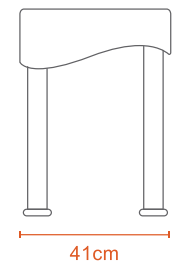
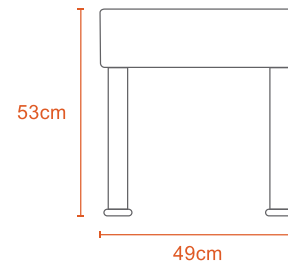





# KIDS SEATING

## CHAIR BABY **ARMLESS**

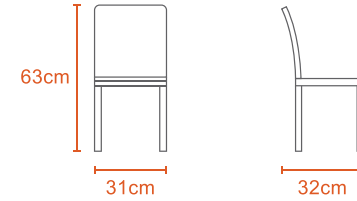

## CHAIR BABY **SOFA**

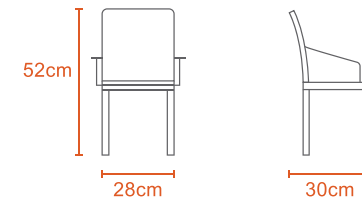



# Contact Us

## Phoenix Showrooms:

### Welisara

No.445, Negombo Road, Welisara,  
Sri Lanka.  
Tel: +94 (0) 77 312 4745

### Panadura

No.12, Mahanama Road, Panadura,  
Sri Lanka.  
Tel: +94 (0) 74 138 8058

### Battaramulla

No.260/1, Pannipitiya Road, Pelawatta,  
Battaramulla, Sri Lanka.  
Tel: +94 (0) 11 254 9971  
+94 (0) 77 494 3659 / 71 525 7154

## #DesignedForLife

[www.phoenix.lk](http://www.phoenix.lk)





A close-up photograph of a white toilet seat and a pink bidet attachment. The bidet is in the foreground, and the toilet seat is partially visible on the right. The background is dark, creating a high-contrast scene.

**DESIGNED  
FOR LIFE**